

SCHOCK

SCHOCK PILA 

541123

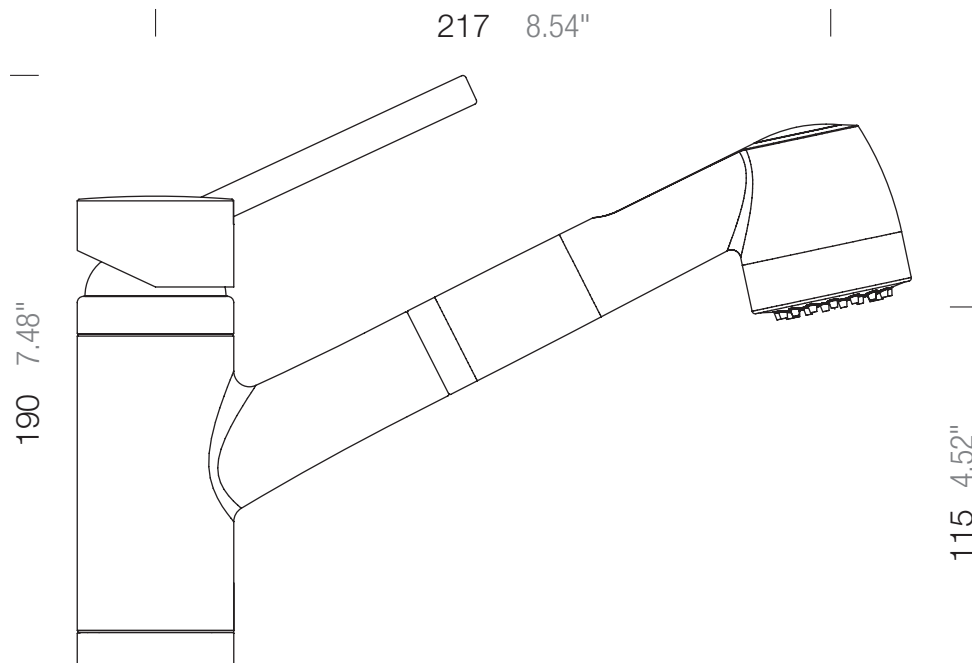

Lochbohrung \varnothing 35

Hole 1.37"